



美特钉系列 特点：

- 1、采用优质镀锌改拔丝，抗拉强度高。
- 2、按国际标准尺寸制作，不卡钉，更耐用。

钉系列(Nails Series)

F直钉系列(F Nails Series) 18 GA



适用枪(Suitable for)

- F32/F32D/F32F/F50C/F50D/F50E/MTF32

规格(Size)

- F10/F15/F20/F25/F30/F32/F35/F38
- F40/F45/F50

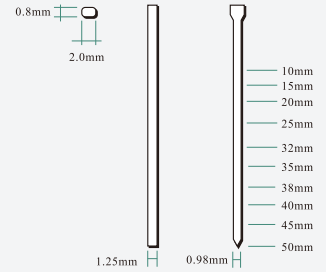

T钉系列(T Nails Series) 16 GA

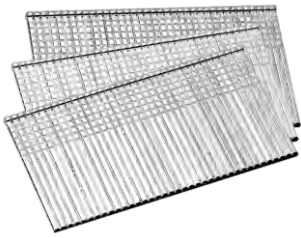

适用枪(Suitable for)

- FST50/T50SA/T50MC/T64A

规格(Size)

- T15/T20/T25/T30/T32/T35/T38/T40
- T45/T50

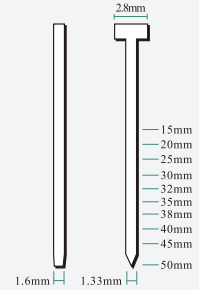

10F钉系列(10F Staples Series) 23 GA



适用枪(Suitable for)

- 1010F/1010FC/1010FL/MT1016F
- MT1016FLN

规格(Size)

- 1005F/1006F/1007F/1008F/1010F
- 1012F/1014F/1016F

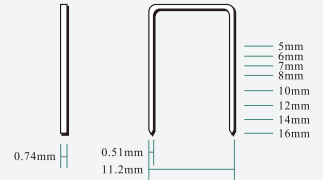

J10钉系列(J10 Staples Series) 20 GA

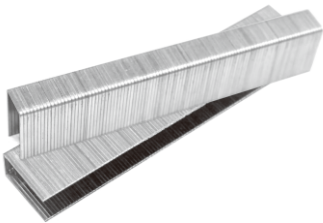

适用枪(Suitable for)

- 1013J/1013JL/1013JB/1022J/1022JB
- MT1016J/MT1016JLN/MT1025J

规格(Size)

- J1006/J1008/J1010/J1013/J1016
- J1019/J1022/J1025

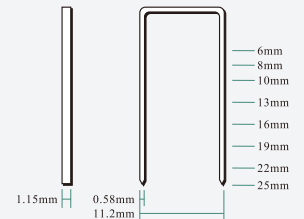

K钉系列(K Staples Series) 18 GA



适用枪(Suitable for)

- 425K/425KL/440KB

规格(Size)

- K10/K13/K16/K19/K22/K25/K28/K30
- K32/K35/K38/K40/K45

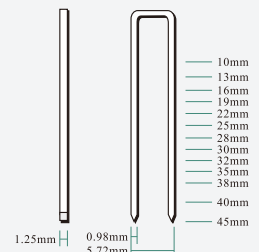

钉系列(Nails Series)

80钉系列(80 Staples Series) 21 GA

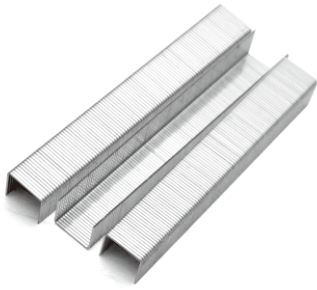

适用枪(Suitable for)

- 8016/8016B/8016BL/MT8016/MT8016LN

规格(Size)

- 8006/8008/8010/8012/8014/8016
- 8018/8020/8022/8025

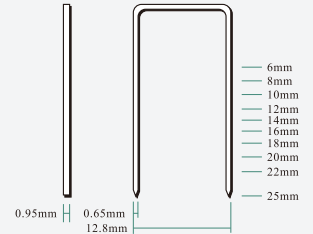

71钉系列(71 Staples Series) 22 GA



适用枪(Suitable for)

- 7116/7116B/7116BL/7116BP/MT7116
- MT7116LN

规格(Size)

- 7104/7106/7108/7110/7112/7114
- 7116

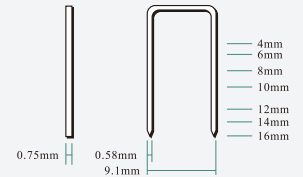

92钉系列(92 Staples Series) 18 GA

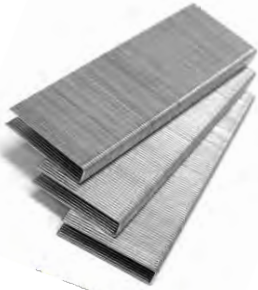

适用枪(Suitable for)

- 9240B

规格(Size)

- 9210/9213/9216/9219/9222/9225
- 9228/9230/9232/9235/9238/9240/9245

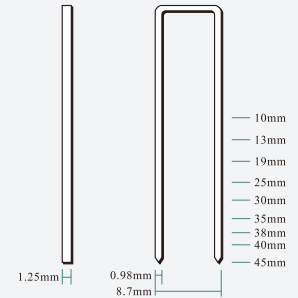

N钉系列(N Staples Series) 16 GA

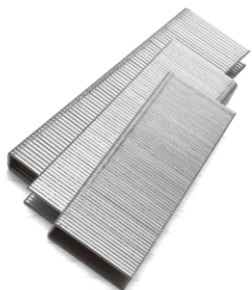

适用枪(Suitable for)

- N851/N851D/N851F

规格(Size)

- 16mm(N10)/19mm(N11)/22mm(N12)
- 25mm(N13)/28mm(N14)/32mm(N15)
- 35mm(N16)/38mm(N17)/40mm(N18)
- 45mm(N19)/50mm(N21)

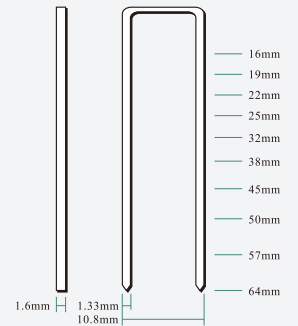

封箱钉系列(Carton Staples Series) 16 GA

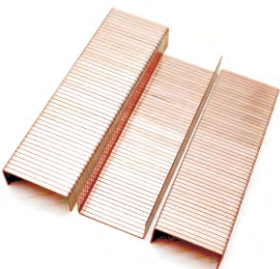

适用枪(Suitable for)

- HB3515/HB3518/ADCS-19/ADCS-22

规格(Size)

- 3515/3518/3522

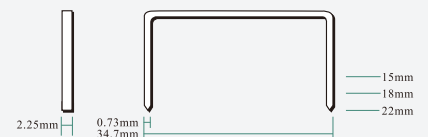

钉系列(Nails Series)

J4钉系列(J4 Staples Series) 20 GA

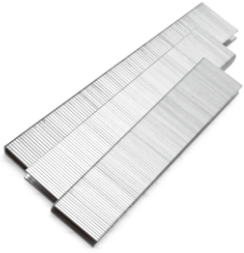

适用枪(Suitable for)

- 406J/413J/422J/422JL/MT425J

规格(Size)

- J406/J408/J410/J413/J416/J419
- J422/J425

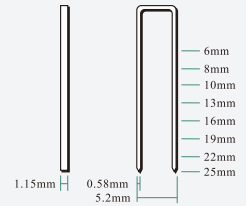

U型钉系列(U Ring Staples Series) 16 GA



适用枪(Suitable for)

- 635TR

规格(Size)

- U19/U25/U35

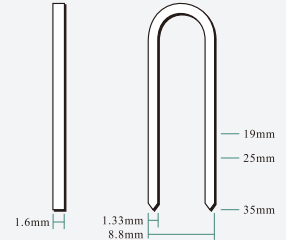

12J钉系列(12J Staples Series) 20 GA



适用枪(Suitable for)

- P88U

规格(Size)

- 1218J/1220J/1222J

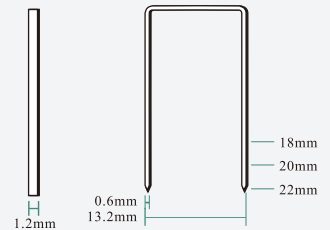

Q钉系列(Q Staples Series) 16 GA

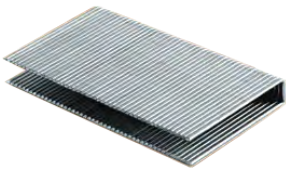

适用枪(Suitable for)

- Q64/Q90

规格(Size)

- Q16/Q19/Q22/Q25/Q28/Q30/Q32
- Q38/Q45/Q55/Q57/Q64

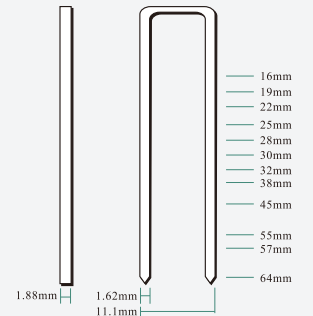

地板钉系列(Flooring Staples Series)16GA

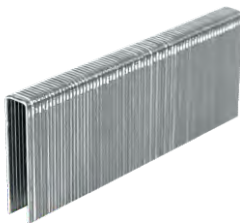

适用枪(Suitable for)

- MFS50

规格(Size)

- 20mm/25mm/28mm/32mm/35mm/38mm
- 40mm/45mm/50mm/57mm/64mm

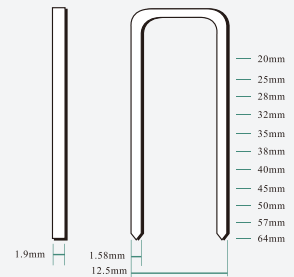

蚊钉系列(Pin Nails Series) 23 GA

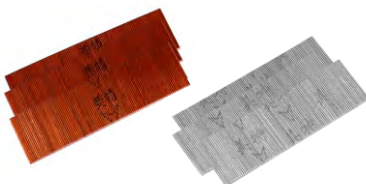

适用枪(Suitable for)

- P616/P622/P622C/P630/P645/MP622
- MP630/MP635/MP650

规格(Size)

- 608/610/612/615/618/620/622/625
- 630/635/640/645/650

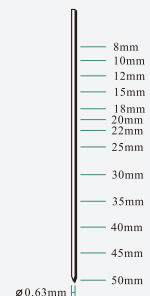

钉系列(Nails Series)

角钉系列(V-Nails Series)

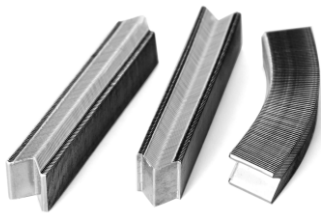

适用枪(Suitable for)

- V1015/V1015B/V1115/V1115B

规格(Size)

- V1007/V1010/V1012/V1015/V1107
- V1110/V1112/V1115

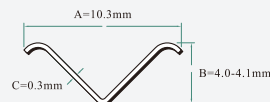

Size: 7, 10, 12, 15mm

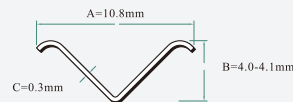

Size: 7, 10, 12, 15mm

C型钉系列(C Ring Staples Series)



适用枪(Suitable for)

- SC7E/SC7C/SC760B/MT-C560/MT-C600

规格(Size)

- SC7E/SC760/C560/C600

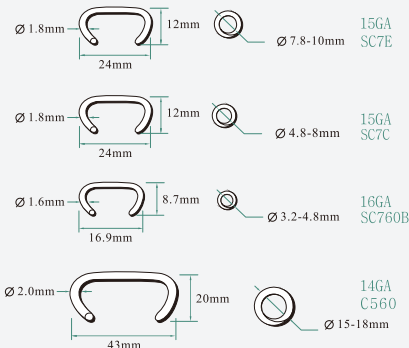
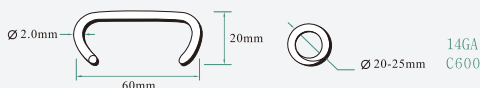

夹码钉系列(Matterss Nails Series)



钉枪型号	U型	U型	规格		
			22mm	19mm	11mm
M65	4.8	12.7	CL-23	CL-73	
		15.5	CL-24	CL-74	
M66	6.2	12.3	CL-3	CL-71	
		14.1	CL-4	CL-72	
		15.5		CL-5	
M45	4.8	10.7			CL-13
		12.7			CL-17
M46	5.8	13.3			CL-18

卷钉系列(Coil Nails Series)



螺纹

适用枪(Suitable for)

- CN452S/CN55/CN55B/CN55C/CN65
- CN70B/CN80B/CN90/CN100/CN130

规格(Size)

- 2.1/2.3/2.5/2.9/3.1/3.3/3.8

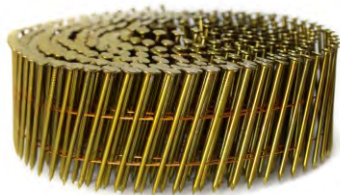
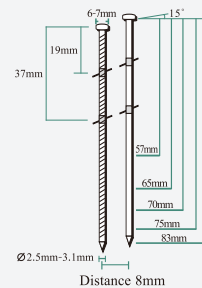

光杆

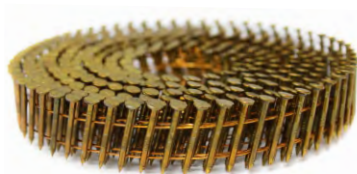

环纹

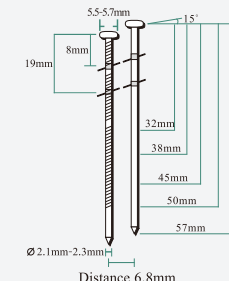
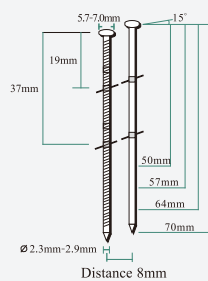



PU弹簧管/伸缩管系列 (PU Coil Tube Series)

规格 Size	外径 O.D (mm)	内径 I.D (mm)	工作压力 Operating Pressure (kgf/cm ²)	爆破压力 Burst Pressure (kgf/cm ²) (20°C)	长度 Length (m)	颜色 Color
PU - CL0850	8	5	8	30	6m 9m 12m 15m	透明 蓝色
PU - CL0855	8	5.5	8	26		桔色 黑色
PU - CL1065	10	6.5	8	28		黄色 红色
PU - CL1280	12	8	8	28		绿色 其他

PU直管系列 (PU Tube Series)



规格 Size	外径 O.D (mm)	内径 I.D (mm)	工作压力 Operating Pressure (kgf/cm ²)	爆破压力 Burst Pressure (kgf/cm ²) (20°C)	长度 Length (m)	颜色 Color
PU - 0425	4	2.5	8	35	200	透明 蓝色 桔色 黑色 黄色 红色 绿色 其他
PU - 0640	6	4	8	35	200	
PU - 0850	8	5	8	30	100	
PU - 0855	8	5.5	8	26	100	
PU - 1065	10	6.5	8	28	100	
PU - 1280	12	8	8	28	100	

产品特点 (FEATURES)

采用100%高等纯正TPU,具有柔韧、耐高压、抗震动、耐磨损、耐绕曲等特性。
应用于气动工具、自动化装配线、仪器机械、输气管道、实验室等行业。

性能数据 (PERFORMANCE DATA)

- 温度范围: (Temperature Range):-40°C~+80°C
- 直径公差: (Tolerance):±0.1mm~±0.15mm
- 硬度: (Hardness):95A, 98A
- 拉力强度: (Tensile Strength):400kgf/cm²
- 断裂伸长率(Elongation):550%
- 撕裂强度: (Tearing Strength):210kgf/cm²



美特快速接头 特点：

- 1、采用高强度材料，经CNC精密加工和特殊热处理制作而成；
- 2、耐磨损，抗腐蚀，防氧化，持久耐用。

快速接头系列(Quick Coupler Series)

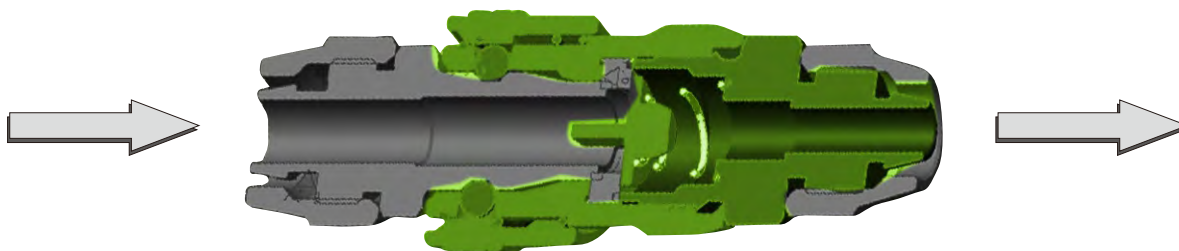

操作说明(Operation instruction)

- 1、此快速接头（母接头）适用于空气压力在15kgf/cm²以内，工作环境使用温度范围在-20℃~+80℃以内。
- 2、连接步骤，先将外环向后拉，插入公插头再将外环向前推入，使不锈钢珠卡入公插头对应的槽内，形成连接状态。
- 3、脱离步骤，先将外环向后拉，公插头自然弹出，形成脱离状态（退出时，公插头须用手接住，以免弹出时发生危险）。

SM系列-外牙型 (SM Series-outer tooth type)

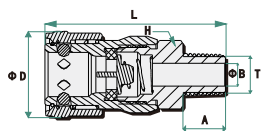

编号 (ITEM NO)	尺寸 (Size) 单位: mm					
	L	ΦD	H	T	ΦB	A
ZK01A1123-20SM	55	27	六角19	1/4PT	7	13
ZK01A1123-30SM	56.5	27	六角19	3/8PT	8	14
ZK01A1123-40SM	59.5	27	六角22	1/2PT	9	16

SH系列-插管型 (SH Series -Cannula type)

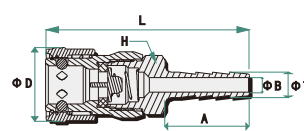

编号 (ITEM NO)	尺寸 (Size) 单位: mm					
	L	ΦD	H	ΦT	ΦB	A
ZK01A1123-20SH	72	27	六角19	Φ8	5.2	30
ZK01A1123-30SH	76.5	27	六角19	Φ10	7.6	34
ZK01A1123-40SH	78.5	27	六角19	Φ13	9	36

SF系列-内牙型 (SF Series -Inner tooth type)

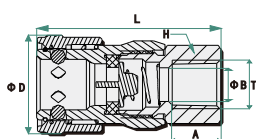

编号 (ITEM NO)	尺寸 (Size) 单位: mm					
	L	ΦD	H	T	ΦB	A
ZK01A1123-20SF	49	27	六角19	1/4PT	9	13
ZK01A1123-30SF	50.5	27	六角21	3/8PT	9	14
ZK01A1123-40SF	52.5	27	六角27	1/2PT	9	14

SP系列-锁管型 (SP Series-Lock tube)

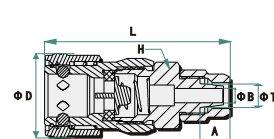

编号 (ITEM NO)	尺寸 (Size) 单位: mm					
	L	ΦD	H	ΦT	ΦB	A
ZK01A1123-20SP	58.5	27	六角19	Φ5x8	4.5	7.4
ZK01A1123-30SP	57	27	六角19	Φ6.5x10	5	6.4
ZK01A1123-40SP	57	27	六角19	Φ8x12	7	8

快速接头系列(Quick Coupler Series)

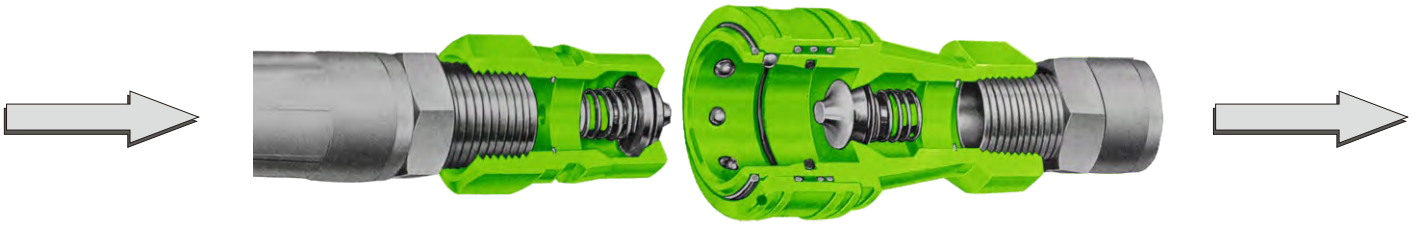

操作说明(Operation instruction)

- 1、此快速接头（子接头）适用于空气压力在15kgf/cm²以内，工作环境使用温度范围在-20℃~+80℃以内。
- 2、连接步骤，先将外环向后拉，插入公插头再将外环向前推入，使不锈钢珠卡入公插头对应的槽内，形成连接状态。
- 3、脱离步骤，先将外环向后拉，公插头自然弹出，形成脱离状态（退出时，公插头须用手接住，以免弹出时发生危险）。

PH系列-插管型

(PH Series-Cannula type)

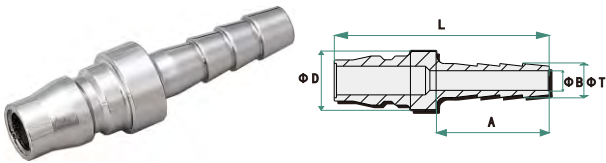

编号 (ITEM NO)	尺寸 (Size) 单位: mm				
	L	ΦD	ΦT	ΦB	A
AK01A-014A(20PH)	57	16	Φ8	5.2	29.8
AK01A-021A(30PH)	61	16	Φ10	7.6	33.8
AK01A-029A(40PH)	63	20	Φ13	7.6	36

PM系列-外牙型

(PM Series-outer tooth type)

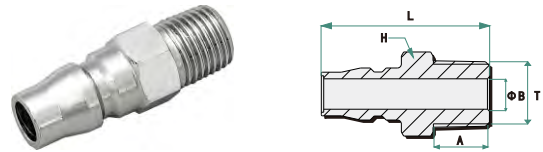

编号 (ITEM NO)	尺寸 (Size) 单位: mm				
	L	H	ΦT	ΦB	A
AK01A-013A(20PM)	41	六角14	1/4PT	7.6	12
AK01A-023A(30PM)	42	六角19	3/8PT	7.6	14
AK01A-031A(40PM)	46	六角22	1/2PT	7.6	16

PP系列-锁管型

(PP Series-Lock tube)

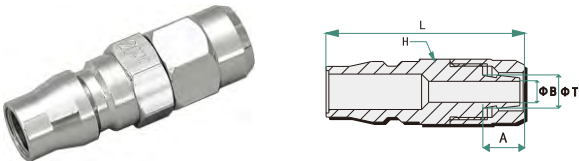

编号 (ITEM NO)	尺寸 (Size) 单位: mm				
	L	H	ΦT	ΦB	A
ZK01A11123-20PP	42.6	六角14	Φ5x8	4.5	8
ZK01A11123-30PP	40	六角17	Φ6.5x10	5	6
ZK01A11123-40PP	41	六角17	Φ8x12	7	8

PF系列-内牙型

(PF Series-Inner tooth type)

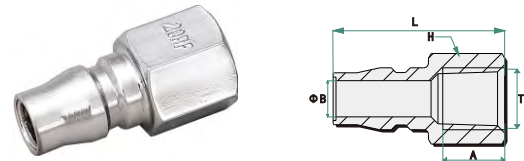

编号 (ITEM NO)	尺寸 (Size) 单位: mm				
	L	H	T	ΦB	A
AK01A-015A(20PF)	36	六角17	1/4PT	7.6	13
AK01A-022A(30PF)	37	六角21	3/8PT	7.6	13
AK01A-030A(40PF)	38	六角27	1/2PT	7.6	15

多管路快速接头(Multi-pipeline aluminum Coupler Series)



特点(Characteristic)

1. 单一进气管路，经本铝座转换成多线管路，节省管线成本可用螺丝固定在机台或墙壁上。
2. 适用于空气压力在15kgf/cm²以内，工作环境适用温度范围在-20℃ ~ +80℃以内。

操作说明(Operation instruction)

1. 依铝座两螺孔间距，钻孔，攻牙，以固定本铝座。
2. 依各人之所需，在平面及两端接上适用之快速接头或管路接头。

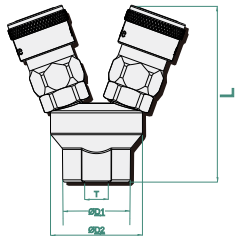

小流量-20SM圆形式二通接头 (Two ways round pipeline aluminum place)

编号(ITEM NO)	L	D1	D2	T	重量(kg)
ZK01A1123-162A-01	80	30	40	1/4PT	0.26

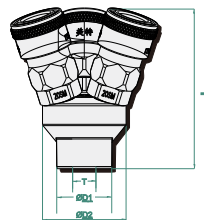

小流量-CA20SM圆形式三通接头 (Three ways round pipeline aluminum place)

编号(ITEM NO)	L	D1	D2	T	重量(kg)
ZK01A1123-163A-01	80	30	40	1/4PT	0.35

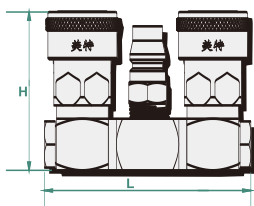

小流量-CA活动式接头 (Three ways round pipeline aluminum place)

编号(ITEM NO)	L	H	T	重量(kg)
ZK01A1123-152A-01	76	58.24	1/4PT	0.35

多管路快速接头(Multi-pipeline aluminum Coupler Series)

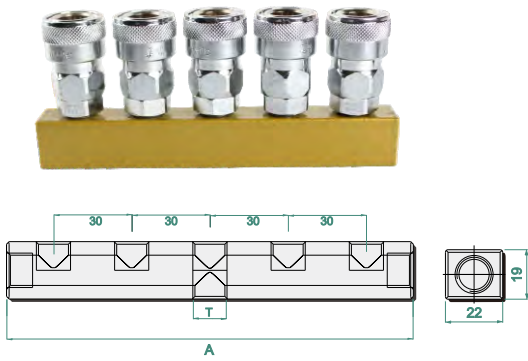

小流量-直立式接头铝座(Multi-pipeline aluminum place)

编号(ITEM NO)	A	T	重量(kg)
ZK01A1123-122A	66	1/4PT	0.264
ZK01A1123-123A	96	1/4PT	0.385
ZK01A1123-124A	126	1/4PT	0.515
ZK01A1123-125A	156	1/4PT	0.619

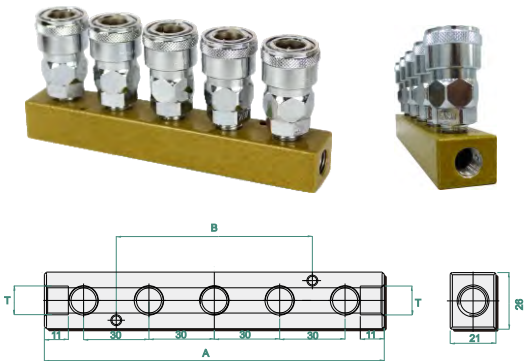

中流量-固定式接头铝座(Multi-pipeline aluminum place)

编号(ITEM NO)	A	B	T	重量(kg)
ZK01A1123-142A	66	0	PT1/4-19	0.277
ZK01A1123-143A	96	30	PT1/4-19	0.411
ZK01A1123-144A	126	60	PT1/4-19	0.544
ZK01A1123-145A	156	90	PT1/4-19	0.680

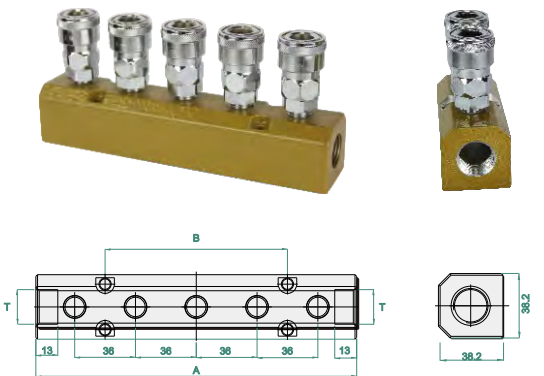

大流量-座立式接头铝座(Multi-pipeline aluminum place)

编号(ITEM NO)	A	B	T	重量(kg)
ZK01A1123-132A	86	0	PT1/2-14	0.444
ZK01A1123-133A	120	36	PT1/2-14	0.640
ZK01A1123-134A	160	72	PT1/2-14	0.858
ZK01A1123-135A	190	108	PT1/2-14	1.046

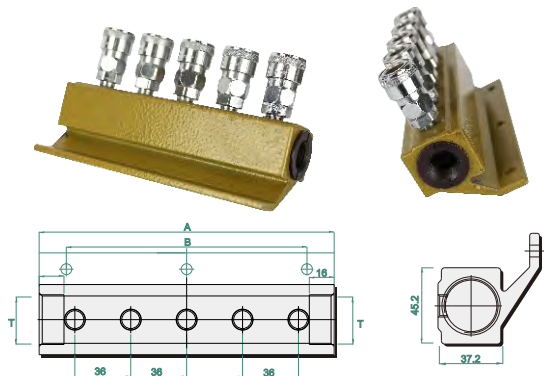

大流量-挂墙式接头铝座(Multi-pipeline aluminum place)

编号(ITEM NO)	A	B	T	重量(kg)
ZK01A1123-112A	86	54	PT1/2-14	0.598
ZK01A1123-113A	120	80	PT1/2-14	0.815
ZK01A1123-114A	160	125	PT1/2-14	1.053
ZK01A1123-115A	190	155	PT1/2-14	1.256

配件系列(Accessories Series)

气缸(Cylinder Set)



上铝顶盖(Cylinder Cap)



缓冲垫(Bumper)



游动阀(Active Valve)



弹夹(Magazine)



撞针(Drive Set)



胶圈(O-ring)



枪嘴(Muzzle)



润滑油(Lubricant)



美特专用润滑油

- 1、每次使用工具前，请加几滴润滑油，最好使用本公司的润滑油，可延长气动工具的使用寿命；
- 2、请勿与机油或其他添加物的油混合使用，使用不当的润滑油会损坏内部零件。

护目镜(Safety Glass)



美特专用护目镜

工作时请配戴防护眼镜，以防灰尘、飞溅物伤害眼睛，确保安全。

美特[®] meite

安全操作注意事项

安全细则

- 一、使用工具前，请仔细阅读说明书。
- 二、请戴安全护目镜与耳罩，以确保安全。
- 三、请勿将枪嘴对准身体，以免造成伤害。
- 四、请勿使用氧气、瓦斯气体等易燃易爆气体为工具动力来源。
- 五、请正确选用钉子规格，以免发生卡钉，造成工具损伤。
- 六、请勿在装钉时扣发扳机。
- 七、工具停止使用或维修时，请务必卸下空气接头并取出弹夹内没有打完的钉子。

动力要求

- 一、请配置空气过滤器，确保空气之清洁，以保证工具寿命。
- 二、无漏气现象，并保持清洁、干燥及管内无杂质、杂屑，以免对工具之零部件造成损害。

操作说明

一、装钉

- 1.卸下空气接头，在无动力下进行，以免造成伤害。
- 2.选择需要之规格钉子。
- 3.拉开退钉器将钉子装入钉槽。
- 4.将推钉器推入（关闭弹夹）。

二、打钉作业

- 1.连接空气源。
- 2.请将枪嘴对准并紧贴工作物，再启动扳机击发。
- 3.请勿空打（弹夹无钉时），以免损坏撞针零件。
- 4.请勿向空击射，以免造成伤害。

三、保养

- 1.请于使用前在空气接头处向内加入1-2滴润滑油，以保持内部零件润滑，增加工作效率与工具寿命。
- 2.请保持弹夹与枪嘴内外清洁，无任何杂物或胶水。
- 3.请勿任意拆卸工具，以免损坏。
- 4.工具如不能正常作业，请在你购买的工具行委托维修。



美特[®]
meite



2015.02



广东美特机械有限公司
GUANGDONG MEITE MECHANICAL CO.,LTD

Http://www.gdmeite.com E-mail: meite@gdmeite.com
Tel: 0757-85122208 85120989 Fax: 0757-85120609
佛山市南海区里水镇和顺和桂工业园B区顺景大道10号